

*classic*  
**UNIBAR**





# UNIBAR *classic* line

**Unibar Classic** is the under-counter or back-counter refrigerator with solid doors, sturdy, reliable and versatile; it is the right equipment for a variety of environments.

Available in 3 versions: **STANDARD - MINI - MAXI** with different depths and different heights, allows you to find a solution for every need.

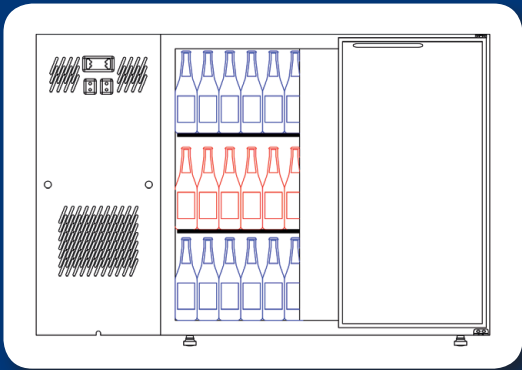

○ STANDARD  
The classic refrigerated back-bar counter, with its **depth of 540 mm** and its **height of 850/875 mm** combines admirably installation flexibility and load carrying capacity, in fact you may store 3 rows of 240 mm-high bottles in every compartment.

○ MINI  
Thanks to its reduced **height, only 715/750 mm** and **3 different depths 560 mm, 630 mm, 685 mm** is ideal for in-building on the Bar counter.



Alternatively, due to its more compact size, this equipment can also be easily installed as a wall hanging. Unusually, this line is based on a single size of doors, to maintain compatibility with the doors and drawers of Ronda model, completely retractable in the cabinet.

o MAXI

With a **height of 850/875 mm** and a **depth increased to 700 mm**, this is the right equipment for those who have large load requirements, up to a maximum of 644 bottles of 33 cl. or 1324 cans of 33 cl. in the model with 4 large doors.

With **Unifrigor**, you can get much benefit from all available space, thanks to the modularity of the refrigerator, available with 1/2/3/4 doors and doors of different sizes, for many different lengths and for better meeting the needs of space.



## SINGLE DOOR

The version with a single door is very useful to fill small spaces and is available in both CHILLERS (+2°/+8° C) and FREEZER (-15°/-25° C) version.

The freezer version is very useful for storing spirits, such as vodka for example, or simply to cool the glasses to be used for serving "SUB ZERO" beers.

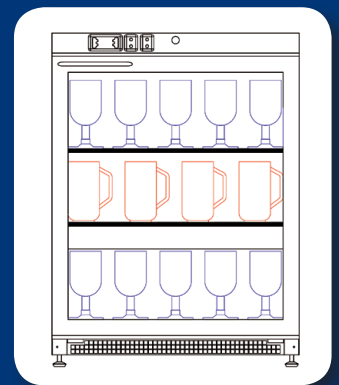
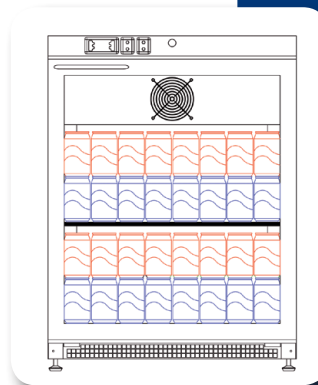

## VISION

The **Vision** model with double doors, front and rear, is ideal to be placed in the centre of round or oval environments.

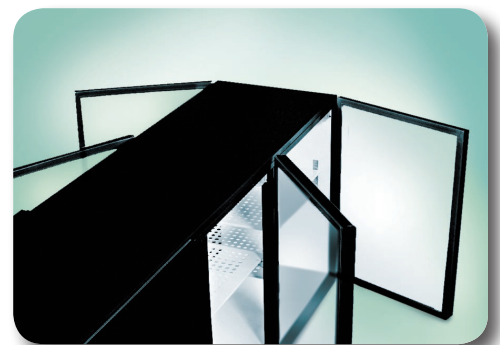

## NEUTRAL COUNTER

To meet the needs related to the implementation of complete furniture, we have designed the **neutral counter**, a non refrigerated storage cabinet. So you gain more space inside, thanks to elimination of the evaporator and you have a non refrigerated storage module beautifully integrated on the side of a refrigerated one.





## THE TOPS

Ideal for in-building, this refrigerator can also be used stand alone if equipped of a working top in stainless steel AISI 304 "Scotch Brite", reinforced with wood, ready made for heavy loads such as a coffee machine, for example.

- A simple top can be assembled without splash-back with rounded front edge (thickness 27 mm) - (photo 1).

- A top similar to a kitchen working top can be assembled, with square front edge and with splash-back (thickness of the top, 40 mm + splash-back 100 mm) - (photo 2).

- A top with the features of a kitchen working top can be assembled, but also equipped with a sink (thickness of the top, 40 mm + splash-back 100 mm - sink size 400 x 290 x 200 mm H) - (photo 3).

This top is supplied without hole for the tap, unless you also buy the tap as an option.

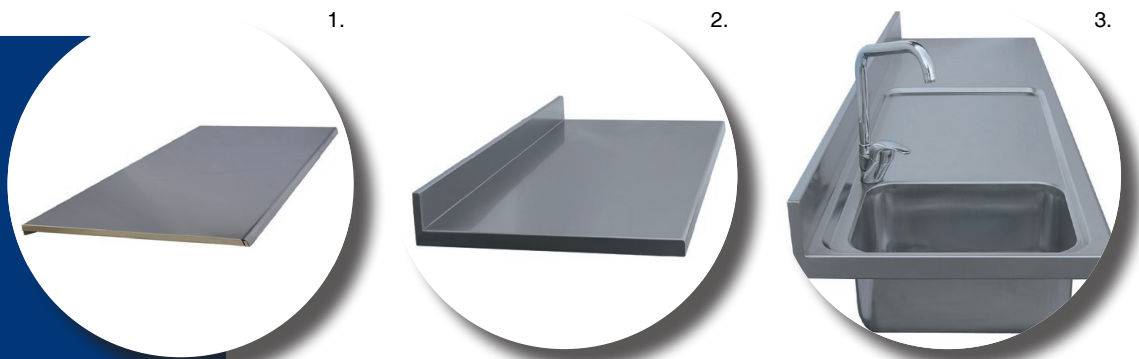

4.



Now, working tops are available for all versions: STANDARD, MINI and MAXI, in all different depths and, on request, we also manufacture customized tops, either for size or type of sink.

## "PIANO BAR" SPECIAL

The MINI line can also be supplied with the special "counter top" that transforms the refrigerator into the structure of a counter, only to be coated.

So you have an easy and immediately ready bar counter at a very low-cost (photo 4).

# UNIBAR *classic*

## structural features

The exterior of the cabinet and doors are in dark grey skinplate (galvanized sheet then plasticized) or stainless steel AISI 304 Scotch Brite. The inside tank is in non-toxic white skinplate for models with dark grey skinplate exterior, and in Stainless Steel 304 Scotch Brite for models with stainless steel exterior. The low power **LED lights** turn on & off thanks to an in-built switch.

Thanks the optional **inversion of the motor position** (motor to the right) you can also place two specular units close to each other, thus obtaining up to 8 consecutive doors without the bad looking interruption of the motor unit.

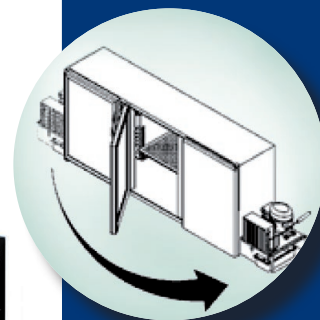

You can customize the cabinet replacing a door with a set of 2 or 3 drawers.



5.



6.



○ The **DRAWERS**, equipped with ball bearing guides to ensure maximum strength and reliability, allow you to pull out completely the drawer, and also place inside certain types of beer and soft drink crates. They can be mounted instead of any type of door, D / DM / DX (photo 5).

○ **NEUTRAL DRAWER**. At the top of the motor unit compartment, we can place a neutral drawer mounted on telescopic guides, useful for storing many small things such as stocks of tea, infusion, sugar bags, or simply to store the cutlery.

○ **COFFEE DRAWER**. A special version of the neutral drawer is also available, equipped with a special container designed to collect coffee grounds (photo 6).





○ EXTERNAL CONDENSING UNITS, to be used on the cabinet without the motor unit within 10 m max (photo 1).

○ The MOTOR UNIT COVER now opens laterally, as a door, and is equipped with a closing magnet. This system make easier to enter the engine compartment, but above all, to have access the condenser to perform the periodic cleaning operations. We have also moved the thermostat to the top of the engine compartment, where, thanks to a more protected location and a moisture free environment, the thermostat life is longer (photo 2).

○ UNIFORM TEMPERATURE SYSTEM

The refrigerating unit is composed of a compressor, a ventilated condenser and an evaporator which placed inside the tank behind the front column. It is protected by non-toxic paint, provided of a pan for collecting defrosting water and two circular axial fans to grant a total uniformity of cold inside the tank (photo 3).

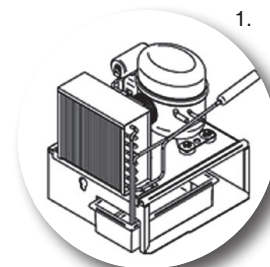

○ KEY LOCK

The contents of your refrigerator are safe at all times, thanks to the possibility to install a key lock on both doors and drawers.

This system can also be installed at a later time (photo 4).

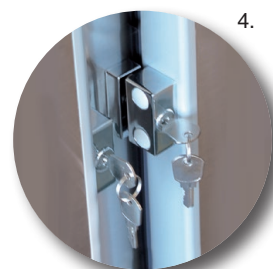

○ SHELF

The standard supply includes an adjustable shelf with hooks for each door, in embossed aluminium on version with dark grey skinplate exterior, and in stainless steel on version with stainless steel exterior (photo 5).

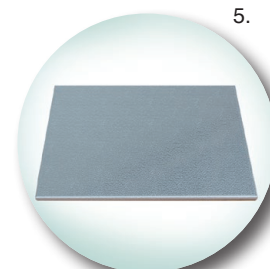

○ FEET AND WHEELS

As standard, aluminium feet is supplied, adjustable from inside of the tank from 30 to 55 mm, or as option an increased size feet is available, but in this case, the adjustment from the inside of the tank is not possible any more. Alternatively, always as an option, the refrigerator can be equipped with braking revolving wheels (photo 6).



UNIBAR  
classic

Climatic class ISO 4

tested for proper operation in environments up to +32°C

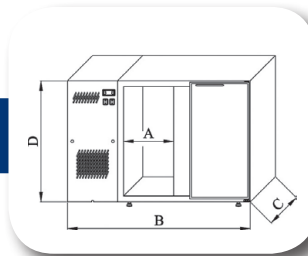

**INTEGRAL**

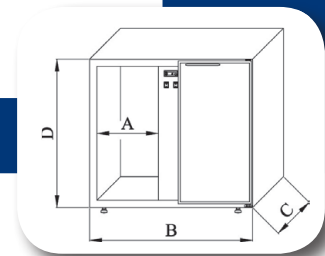

**REMOTE**

**DIMENSIONS OF STANDARD CABINETS 540 mm DEPTH**

Integral / Remote	max load capacity (33 cl cans )	n° doors	n° feet	A	B	C	D
RO 1240 2D / SG 900 2D	360	2 small	4	340	1240 /900	540	850/875 without feet 820
RO 1740 3D / SG 1400 3D	642	3 small	4		1740 /1400		
RO 1350 2DM / SG 1010 2DM	432	2 medium	4	404	1350 /1010		
RO 1880 3DM / SG 1540 3DM	756	3 medium	4		1880 /1540		
RO 2400 4DM / SG 2060 4DM	1008	4 medium	6		2400 /2060		
RO 1540 2DX / SG 1200 2DX	504	2 large	4	489	1540 /1400		
RO 2140 3DX / SG 1800 3DX	870	3 large	6		2140 /1800		
RO 2740 4DX / SG 2400 4DX	1236	4 large	8		2740 /2400		

**DIMENSIONS OF MINI CABINETS 715/740 mm HIGH**

ROS 1430 2DDM /SGS 1090 2DDM	312	2 one size	4	442	1430 /1090	560	715/740 without feet 685
ROS 1995 3DDM /SGS 1655 3DDM	540	3 one size	4		1995 /1655		
ROS 2560 4DDM /SGS 2220 4DDM	768	4 one size	6		2560 /2220		
ROS/M 1430 2DDM /SGS/M 1090 2DDM	360	2 one size	4		1430 /1090	630	
ROS/M 1995 3DDM /SGS/M 1655 3DDM	624	3 one size	4				
ROS/M 2560 4DDM /SGS/M 2220 4DDM	888	4 one size	6				
ROS/X 1430 2DDM /SGS/X 1090 2DDM	408	2 one size	4	442	1430 /1090	685	
ROS/X 1995 3DDM /SGS/X 1655 3DDM	708	3 one size	4		1995 /1655		
ROS/X 2560 4DDM /SGS/X 2220 4DDM	1008	4 one size	6		2560 /2220		

**DIMENSIONS OF MAXI CABINETS 700 mm DEPTH**

ROX 1350 2DM /SGX 1010 2DM	612	2 medium	4	404	1350 /1010	700	850/875 without feet 820
ROX 1880 3DM /SGX 1540 3DM	1014	3 medium	4		1880 /1540		
ROX 2400 4DM /SGX 2060 4DM	1320	4 medium	6		2400 /2060		
ROX 1540 2DX /SGX 1200 2DX	714	2 large	4	489	1540 /1400		
ROX 2140 3DX /SGX 1800 3DX	1164	3 large	6		2140 /1800		
ROX 2740 4DX /SGX 2400 4DX	1572	4 large	8		2740 /2400		

**DIMENSIONS OF VISION CABINETS 590 mm DEPTH**

ROV 1240 4D / SGV 900 4D	360	4 small	4	340	1240 /900	590	850/875 without feet 820
ROV 1740 6D / SGV 1400 6D	642	6 small	4		1740 /1400		
ROV 1350 4DM / SGV 1010 4DM	432	4 medium	4	404	1350 /1010		
ROV 1880 6DM / SGV 1540 6DM	756	6 medium	4		1880 /1540		
ROV 2400 8DM / SGV 2060 8DM	1008	8 medium	6		2400 /2060		
ROV 1540 4DX / SGV 1200 4DX	504	4 large	4	489	1540 /1400		
ROV 2140 6DX / SGV 1800 6DX	870	6 large	6		2140 /1800		
ROV 2740 8DX / SGV 2400 8DX	1236	8 large	8		2740 /2400		

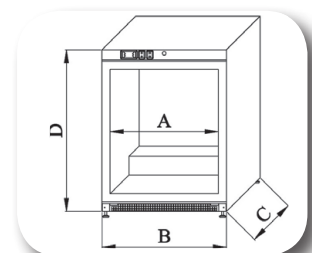

**CHILLERS / FREEZERS**

**DIMENSIONS OF SINGLE DOOR CABINETS**

Chillers / Freezers	max load capacity (33 cl cans )	n° doors	n° feet	A	B	C	D
RO 630 1DU / RON 630 1DU	176	1 one size	4	540	630	567	850/875 without feet 820

No rights may be derived from the information contained in this brochure. We reserve the rights to make changes at any time without notice.



# UNIBAR *classic*



S.S. 31 n. 22  
15040 Occimiano (AL) - Italy  
Tel. + 39 0142 809256  
Fax + 39 0142 809557

[www.unifrigor.com](http://www.unifrigor.com)  
[info@unifrigor.com](mailto:info@unifrigor.com)

